

## ISOMETER® IRDH575

Insulation monitoring device for unearthed AC, DC and AC/DC systems (IT systems) with control and display function for EDS insulation fault location systems



## ISOMETER® IRDH575

Insulation monitoring device for unearthed AC, DC and AC/DC systems (IT systems) with control and display function for EDS insulation fault location systems



ISOMETER® IRDH575

### Device features

- Universal application in 3(N)AC, AC/DC and DC IT systems 20...575 V/340...760 V
- Response range 1 kΩ...10 MΩ
- Info button for the indication of various parameters and the system leakage capacitance
- Comprehensive self-monitoring function including system fault alarm relay
- Internal/external test and reset button
- Two separate alarm relays, N/C or N/O operation selectable
- Backlit plain text display 4 x 16 characters
- RS-485 interface
- Data memory, disconnection from supply and 0/4...20 mA current output
- Can be extended to an insulation fault location system for max.1080 circuits
- Adjustable locating current for insulation fault location
- Appropriate for EDS4... insulation fault location systems
- AMP measurement method

### Approvals



### Product description

The ISOMETER® of the IRDH575 series monitors the insulation resistance of unearthed power supplies (IT systems). It is suitable for universal use in 3(N)AC, AC/DC and DC systems. AC systems may include extensive DC-supplied loads, such as converters or thyristor-controlled DC drives. The IRDH575 in combination with EDS4... series insulation fault locators and the appropriate measuring current transformers is designed to set up the respective equipment for insulation fault location.

### Function insulation monitoring

When the insulation resistance between the system conductors and earth falls below the set response value, the alarm relays switch and the alarm LEDs light up. Two separately adjustable alarm relays (N/C or N/O operation) allow a distinction to be made between "prewarning" and "alarm". The measured value is indicated on the LC display or an externally connectable measuring instrument. In this way any changes, for example when circuits are connected to the system, can be recognised easily. The fault message can be stored. The fault memory can be reset by pressing the internal or external reset button. By pressing the test button, the function of the device as well as the connections to system and earth can be tested. Pressing the Info key provides additional information, such as the existing system leakage capacitance or device settings.

### Function insulation fault location

Insulation fault location is carried out with EDS4... series insulation fault locators and the respective measuring current transformers. When the IRDH575 detects an insulation fault, the insulation fault location process is started automatically or manually. The IRDH575 generates a locating current the amplitude of which is dependent on the existing system voltage and the insulation fault. When low-resistance insulation faults occur, the locating current is limited by the IRDH575. This limit value can be set via an appropriate menu. The locating current pulse flows from the IRDH575 via the live parts, taking the shortest path to the location of the insulation fault. From there, it flows via the insulation fault and the PE back to the IRDH575. This locating current pulse is then detected by the measuring current transformers located in the insulation fault path, and is evaluated by the EDS... insulation fault locators. When the locating current in the measuring current transformer exceeds the response value, the associated alarm LED at the EDS47... lights up indicating the faulty subcircuit. This information is also indicated on the LC display of the IRDH575. By assigning the measuring current transformers to the respective circuit, the point of fault can easily be detected.

### Additional functions

99 alarm messages with date and time can be stored in the data memory of the IRDH575. The device also includes Isometer disconnecting relays when several ISOMETER®s are operated in (coupled) IT systems. An integrated RS-485 interface (BMS protocol) allows information exchange with other Bender devices.

Via the 0/4-20mA interface details about the insulation resistance can be transferred to higher-level control systems.

The function of the IRDH575 is continuously monitored. When a system fault occurs, the associated alarm LED lights up and the respective alarm relay switches.

### System design

Basically, an EDS system consists of an IRDH575 and one or several EDS4... insulation fault locators with the associated measuring current transformers. Information exchange between the EDS4... and the IRDH575 takes place via a time and cost-saving RS-485 interface. Such a system may include up to 90 EDS4... so that a total of 1080 circuits can be monitored.

### Standards

The ISOMETER® of the IRDH575 series complies with the requirements of the device standards: DIN EN 61557-8 (VDE 0413-8), EN 61557-8, IEC 61557-8, IEC 61326-2-4, DIN EN 60664-1 (VDE 0110-1), DIN EN 60664-3, DIN EN 61557-9, VDE 0413-9, IEC 61557-9, ASTM F1669M-96 (2007), ASTM F1207M-96 (2007)

Operating elements

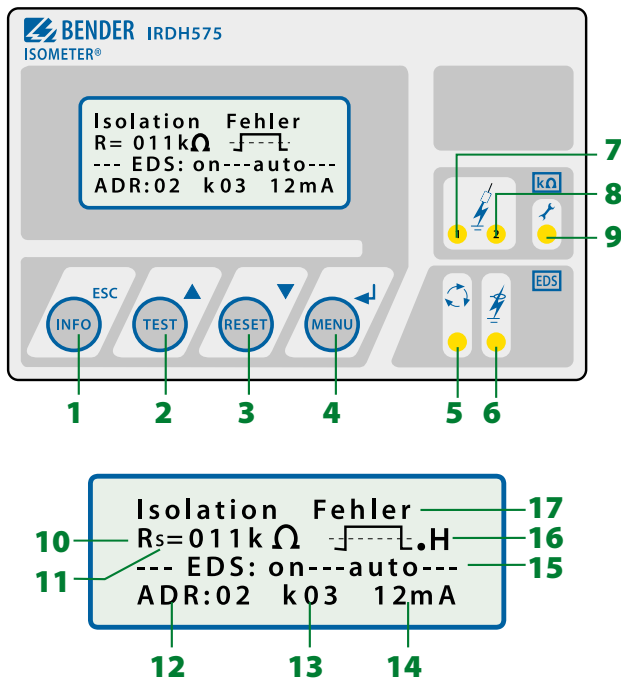

- 1 - "INFO" button: to query standard information  
ESC button: back (menu function), confirms parameter changes
- 2 - "TEST" button: to call up the self test (Isometer function only)  
Arrow up button: parameter change, to move up in the menu
- 3 - "RESET" button: to delete insulation fault alarms (Isometer function only)  
Arrow down button: parameter change, to move down in the menu
- 4 - "MENU" button: to call up the menu system.  
Enter button: to confirm parameter changes
- 5 - EDS LED lights: Insulation fault location has been started
- 6 - EDS alarm LED lights: Insulation fault localised
- 7 - Alarm LED "1" lights: insulation fault, first warning level reached
- 8 - Alarm LED "2" lights: insulation fault, second warning level reached
- 9 - LED lights: Device error
- 10 - Indication of the insulation resistance in kΩ
- 11 - Additional information about the insulation resistance:  
+ = Fault at L+, - = Fault at L-, s = A new measuring process has been started.
- 12 - Bus address of the testing EDS46...  
(indication in case of fault detection)
- 13 - Channel being monitored by EDS4...  
(indication in case of fault detection)
- 14 - Locating current in mA or μA (indication in case of fault detection)
- 15 - EDS in AUTO mode und just running. Further modes are: on, off, pos: address and channel of the EDS can be predefined (in the Master mode only). 1 cycle: When all the channels have been checked once, the EDS will be deactivated.
- 16 - Polarity of the locating current. Point = valid BMS traffic, H = a new entry is made in the history memory.
- 17 - Plain text fault messages

Wiring diagram

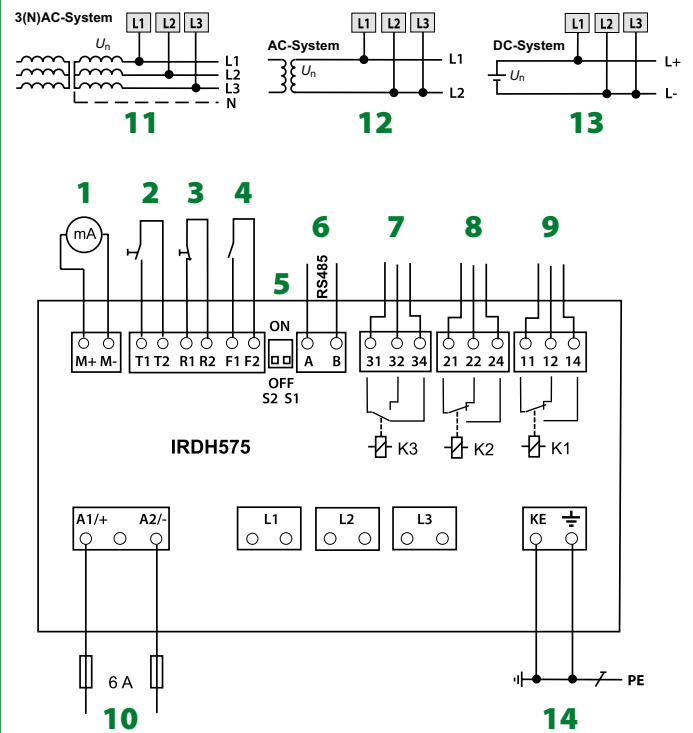

- 1 - For external indicating instrument  
Current output 0...20 mA or 4...20 mA
  - \*2 - External test button "T1, T2" (N/O contact)
  - \*3 - External reset button "R1, R2" (N/C contact or wire jumper),  
(with the terminals open and the ISO-SETUP setting Memory:off, insulation faults will not be stored)
  - \*4 - STANDBY, when the contact is closed, no insulation measurement is carried out; disconnection from the IT system being monitored
  - 5 - S1 = ON : Termination of the serial RS-485 interface (A/B) with 120 Ω  
S2 = not wired
  - 6 - Serial RS-485 interface (BMS bus)
  - 7 - Alarm relay "K3" (device error and EDS alarm) (addr.: 1)
  - 8 - Alarm relay "K2" (insulation fault 2); available changeover contacts
  - 9 - Alarm relay "K1" (insulation fault 1); available changeover contacts
  - 10 - Supply voltage  $U_S$  (see nameplate) via 6 A fuse; for UL and CSA applications, it is mandatory to use 5 A fuses.
  - 11 - Connection to the 3AC system to be monitored:  
Connect terminals L1, L2 L3 to conductor L1, L2, L3
  - 12 - Connection to the AC system to be monitored:  
Connect L1 to conductor L1 and terminals L2, L3 to conductor L2
  - 13 - Connection to the DC system to be monitored:  
Connect L1 to conductor L+ and terminals L2, L3 to conductor L-
  - 14 - Separate connection of  $\overline{\text{PE}}$  and KE to PE
- \* The terminal pairs 2, 3 and 4 have to be wired electrically isolated and must not be connected to PE!

**Characteristic curve – Max. AC voltage between system and earth in the frequency range < 50 Hz**

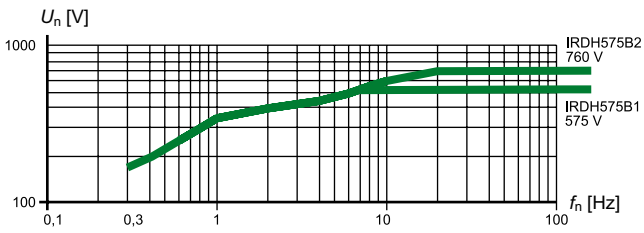

**Characteristic curve response times**

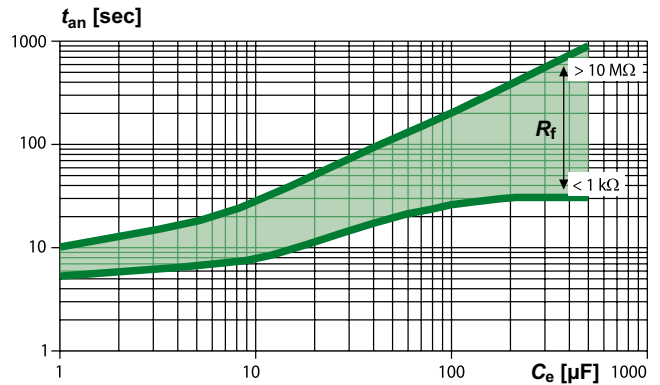

**Wiring diagram – rear view**

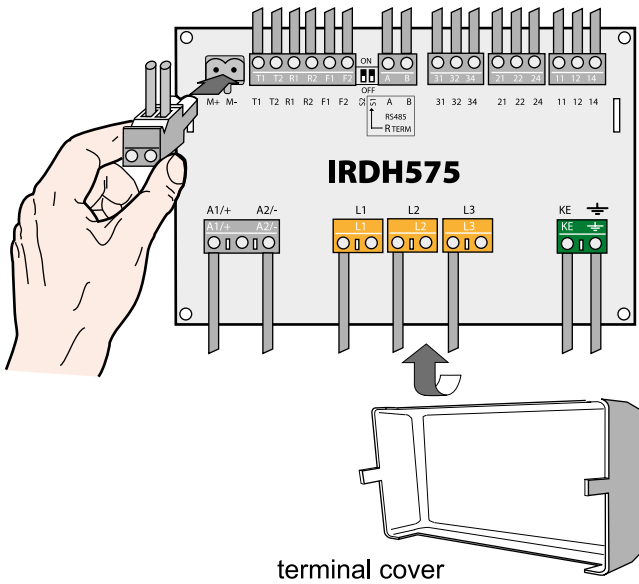

**System structure – Example**

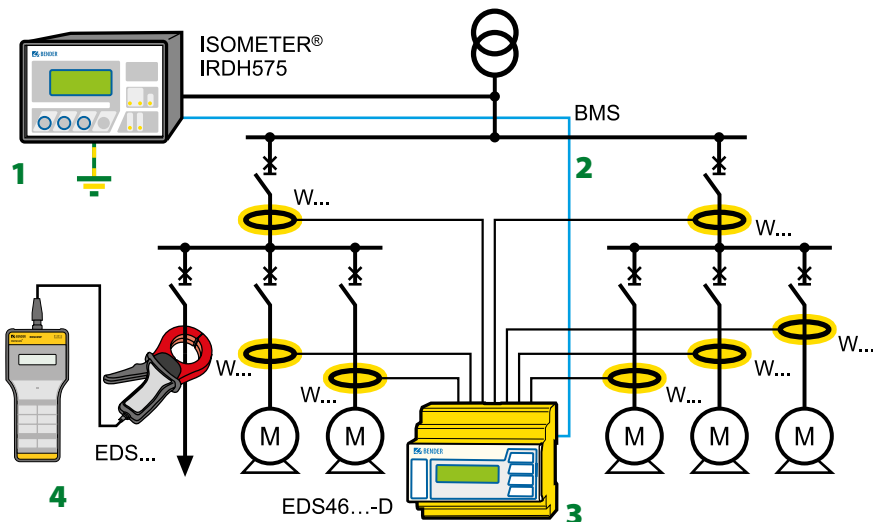

- 1 - ISOMETER® IRDH575
- 2 - RS-485/BMS protocol
- 3 - EDS460/EDS461
- 4 - EDS3090/EDS3091

Typical circuit EDS460 insulation fault location system with IRDH575

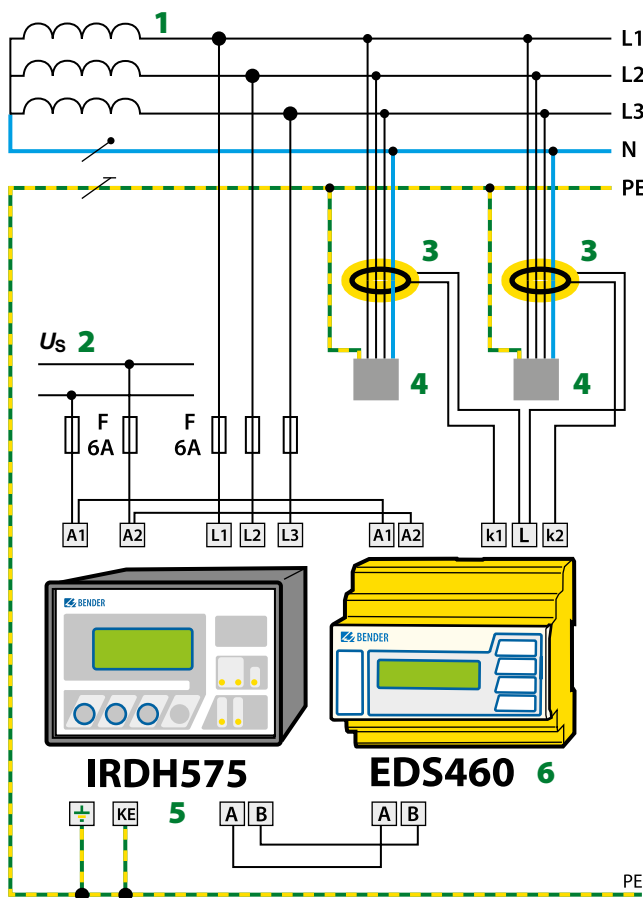

EDS system with IRDH575, EDS460 and measuring current transformers W... in a 3AC system

- 1 - 3AC, 3NAC, DC 20...575 V bzw. 3AC, 3NAC, DC 340...760 V
- 2 -  $U_s$  see ordering information, 6 A fuse recommended.  
Note: Supply voltage  $U_s$  in the IT system requires two fuses.
- 3 - Measuring current transformers W...
- 4 - Outgoing circuits to the loads
- 5 - ISOMETER® IRDH575
- 6 - Insulation fault locator EDS460

Typical circuit EDS461 insulation fault location system with IRDH575

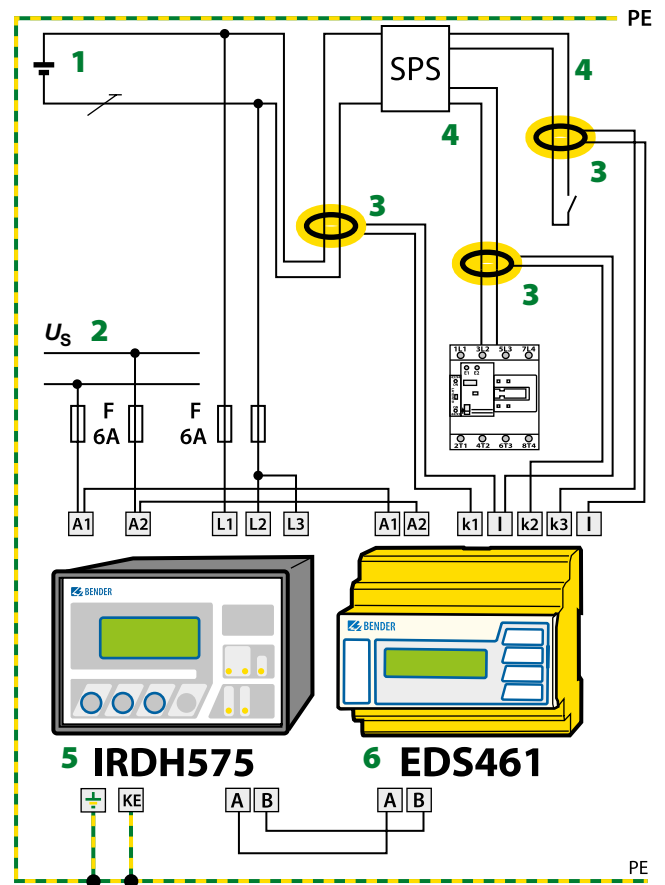

- 1 - AC 20...265V/DC 20 V...308 V
- 2 -  $U_s$  see ordering information, 6 A fuse recommended.  
Note: Supply voltage  $U_s$  in the IT system requires two fuses.
- 3 - Measuring current transformers W.../8000
- 4 - Outgoing circuits PLC: inputs and outputs
- 5 - ISOMETER® IRDH575
- 6 - Insulation fault locator EDS461

**Design of an insulation fault location system with EDS461**

The example above shows an EDS461 system in a DC system for the supply of a programmable logic controller (PLC). Due to the fact that the inputs of PLC systems are very sensitive, the use of an EDS461 is recommended.

The locating current of the IRDH575 is to be set to max. 2.5 mA or as necessary to 1 mA, in order to avoid influences on the PLC system.

## Technical data

### Insulation coordination acc. to IEC 60664-1

Rated insulation voltage	AC 800 V
Rated impulse voltage/pollution degree	8 kV/3

### Voltage ranges

#### IRDH575B1-4235:

Nominal system voltage $U_n$	AC, 3/(N)AC 20...150 V*
Nominal frequency $f_n$	50...460 Hz
Nominal system voltage $U_n$	DC 20...150 V*

#### IRDH575B1-435:

Nominal system voltage $U_n$	AC, 3/(N)AC 20...575 V*
Nominal frequency $f_n$	50...460 Hz
Nominal system voltage $U_n$	DC 20...575 V*

#### IRDH575B2-435:

Nominal system voltage $U_n$	AC, 3/(N)AC 340...760 V*
Nominal frequency $f_n$	50...460 Hz
Nominal system voltage $U_n$	DC 340...575 V*

#### IRDH575B1-435:

Supply voltage $U_S$ (also see nameplate)	AC 88...264 V*
Frequency range $U_S$	42...460 Hz
Supply voltage $U_S$ (also see nameplate)	DC 77...286 V*

#### IRDH575B1-427:

Supply voltage $U_S$ (also see nameplate)	AC 19.2...55 V*
Frequency range $U_S$	42...460 Hz
Supply voltage $U_S$ (also see nameplate)	DC 19.2...72 V*
Power consumption	≤ 14 VA

### Response values

Response value $R_{an1}$ (Alarm1)	1 kΩ...10 MΩ
Response value $R_{an2}$ (Alarm2)	1 kΩ...10 MΩ
Relative uncertainty (20 kΩ...1 MΩ) (acc. to IEC 61557-8)	±15 %
Relative uncertainty (1...20 kΩ)	+2 kΩ/+20 %
Relative uncertainty (1...10 MΩ)	0.2 MΩ/+20 %
Measuring time	see characteristic curves
Hysteresis (1...10 kΩ)	+2 kΩ
Hysteresis (10 kΩ...10 MΩ)	25 %

### Measuring circuit for insulation measurement

Measuring voltage $U_m$	≤ 40 V
Measuring voltage $U_m$ (IRDH575B1-4227)	≤ 10 V
Measuring current $I_m$ (at $R_F = 0\Omega$ )	≤ 220 μA
Internal DC resistance $R_i$	≥ 180 kΩ
Impedance $Z_i$ at 50 Hz	≥ 180 kΩ
Permissible extraneous DC voltage $U_{fg}$ (variant B1)	≤ DC 810 V
Permissible extraneous DC voltage $U_{fg}$ (variant B2)	≤ DC 1060 V
System leakage capacitance $C_e$	500 μF
Factory setting $C_e$	150 μF

### Measuring circuit for insulation fault location (EDS)

Locating current $I_L$ DC	1/2.5/10/25/50 mA
Test pulse/break	2/4 s

### Displays

Display, illuminated	four-line display
Characters (number of characters)	4 x 16
Display range measured value	1 kΩ...10 MΩ
Operating uncertainty (20 kΩ...1 MΩ) (acc. to IEC 61557-8)	±15 %**
Operating uncertainty (1...20 kΩ)	±1 kΩ/15 %**
Operating uncertainty (1...10 MΩ)	±0.1 MΩ/15 %**

### Outputs/Inputs

Test/reset button	internal/external
Current output for measuring instrument SKMP (scale centre point = 120 kΩ):	
Current output IRDH575 (max. load)	0/4...20 mA (≤ 500 Ω)
Accuracy current output (1 kΩ...1 MΩ)	±10 %, ±1 kΩ

### Serial interface

Interface/protocol	RS-485/BMS
Max. cable length	≤ 1200 m
Cable (twisted in pairs, one end of shield connected to PE)	recommended: J-Y(St)Y min. 2 x 0.8
Terminating resistor	120 Ω (0.5 W)

### Switching elements

Switching components	3 changeover contacts: K1 (Alarm 1), K2 (Alarm2), K3 (device error, additionally selectable EDS alarm)
Operating principle K1, K2	N/O or N/C operation
Factory setting (Alarm 1/Alarm 2)	N/O operation
Operating principle K3	N/C operation
Electrical endurance, number of cycles	12000
Contact class	IIB (DIN IEC 60255-23)
Rated contact voltage	AC 250 V/DC 300 V
Making capacity	AC/DC 5 A
Breaking capacity	2 A, AC 230 V, cos phi = 0.4 – 0.2 A, DC 220 V, L/R = 0.04 s
Contact rating at DC 24 V	≥ 2 mA (50 mW)

### Environment/EMC

EMC	acc. to IEC 61326-2-4 Ed. 1.0
Shock resistance IEC 60068-2-27 (device in operation)	15 g/11 ms
Bumping IEC 60068-2-29 (transport)	40 g/6 ms
Vibration resistance IEC 60068-2-6 (during operation)	1 g/10...150 Hz
Vibration resistance IEC 60068-2-6 (transport)	2 g/10...150 Hz
Ambient temperature (during operation)	-10...+55 °C
Ambient temperature (during storage)	-40...+70 °C
Climatic class acc. to DIN IEC 60721-3-3	3K5

### Connection

Connection	screw-type terminals
Connection properties	
rigid/flexible	0.2...4 mm <sup>2</sup> /0.2...2.5 mm <sup>2</sup>
flexible with ferrules without/with plastic sleeve	0.25...2.5 mm <sup>2</sup>
Conductor sizes (AWG)	24...12

### Other

Operating mode	continuous operation
Mounting	display-oriented
Distance to adjacent devices	≥ 30 mm
Degree of protection, internal components (DIN EN 60529)	IP30
Degree of protection, terminals (DIN EN 60529)	IP20
Degree of protection, for door mounting (DIN EN 60529)	IP40
Degree of protection, for door mounting with panel sealing (DIN EN 60529)	IP42
Degree of protection, for mounting the transparent front plate cover (DIN EN 60529)	IP65
Type of enclosure: suitable for panel mounting	free from halogen
Flammability class	UL94 V-0
Documentation number	D00089
Weight	≤ 900 g

### Option "W"

Shock resistance IEC 60068-2-27 (device in operation)	30 g/11 ms
Bumping IEC 60068-2-29 (transport)	40 g/6 ms
Vibration resistance IEC 60068-2-6	1.6 mm/10...25 Hz
	4 g/25...150 Hz
Ambient temperature, during operation	-25...+70 °C
Ambient temperature, during operation	> 55 °C (not for continuous operation in the insulation fault location mode with 50 mA)
Ambient temperature for storage	-40...+85 °C

The data labelled with an \* are absolute values

\*\* = Under EMC test conditions in accordance with IEC 61326-2-4 the specified tolerances can double

### Ordering information

Permissible extraneous DC voltage $U_{fg}$	Nominal system voltage $U_n$		Supply voltage $U_s$		Type	Art. No.
	AC	DC	AC	DC		
$\leq 810\text{ V}$	20...575 V	20...575 V	19.2...55 V	19.2...72 V	IRDH575B1-427	B91065502
			77...286 V	88...264 V	IRDH575B1-435	B91065500
	20...150 V	20...150 V	19.2...55 V	19.2...72 V	IRDH575B1-4227 <sup>1)</sup>	B91065505
			77...286 V	88...264 V	IRDH575B1-4235	B91065504
$\leq 1060\text{ V}$	340...760 V	340...575 V	19.2...55 V	19.2...72 V	IRDH575B2-427	B91065506
			77...286 V	88...264 V	IRDH575B2-435	B91065503

<sup>1)</sup> Measuring voltage  $U_m$  10 V (version -4227) for usage in control circuits

Device "Option-W" with increased resistance to shock and vibrations: Indicated by the letter "W" at the end of the order number.

### Suitable system components

Designation	Type	Art. No.
Panel seal for IP 42	–	B98060006
Transparent cover for IP 65	–	B98060007
Adapter for DIN rail mounting	–	B98060010
Measuring instruments	9620-1421	B986841
	9620S-1421	B986842

### Dimension diagram X500

Dimensions in mm

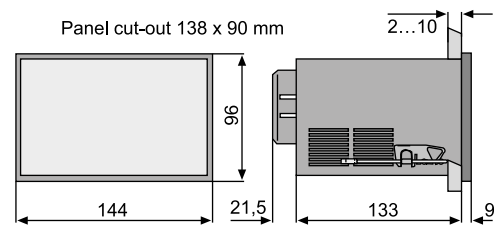



**Bender GmbH & Co. KG**

P.O. Box 1161 • 35301 Gruenberg • Germany  
Londorfer Strasse 65 • 35305 Gruenberg • Germany  
Tel.: +49 6401 807-0 • Fax: +49 6401 807-259  
E-Mail: [info@bender.de](mailto:info@bender.de) • [www.bender.de](http://www.bender.de)



**BENDER Group**