



ISOMETER® isoPV425 with AGH420 coupling device

AC/DC

PV



Insulation monitoring device for unearthed
DC circuits (IT systems)
for photovoltaic systems up to 3(N)AC, AC 690 V / DC 1000 V
Software version: D404 V2.xx



Bender GmbH & Co. KG

Londorfer Str. 65 • 35305 Gruenberg • Germany

Postfach 1161 • 35301 Gruenberg • Germany

Tel.: +49 6401 807-0

Fax: +49 6401 807-259

E-Mail: info@bender.de

Web: <http://www.bender.de>

<http://www.bender-emobility.com>

© Bender GmbH & Co. KG

All rights reserved.

Reprinting only with permission
of the publisher.

Subject to change!

Table of Contents

1. Important information	6
1.1 How to use this manual	6
1.2 Technical support: Service and support	7
1.2.1 First level support	7
1.2.2 Repair service	7
1.2.3 Field service	8
1.3 Training courses	9
1.4 Delivery conditions	9
1.5 Inspection, transport and storage	9
1.6 Warranty and liability	10
1.7 Disposal	11
2. Safety instructions	12
2.1 General safety instructions	12
2.2 Work activities on electrical installations	12
2.3 Intended use	13
3. Function	14
3.1 Device characteristics	14
3.2 Functional description	15
3.2.1 Monitoring the insulation resistance	16
3.2.2 Undervoltage/overvoltage monitoring	17
3.2.3 Self test/error codes	17
3.2.4 Malfunction	20
3.2.5 Signalling assignment of the alarm relays K1/K2	20
3.2.6 Measuring and response times	21
3.2.7 Password protection (on, OFF)	22
3.2.8 Factory setting FAC	22
3.2.9 External, combined test or reset button T/R	22

3.2.10	Fault memory	23
3.2.11	History memory HiS	23
3.2.12	Interface/protocols	23
4.	Installation, connection and commissioning	25
4.1	Installation	25
4.2	Connection	27
4.3	Commissioning	30
5.	Operation of the device	31
5.1	Display elements in use	32
5.2	Menu structure	33
5.3	Menu "AL"	34
5.3.1	Response value setting	34
5.4	Menu "out"	35
5.4.1	Configuration of the relay operating mode	35
5.4.2	Relay alarm assignment "r1" and "r2" and LED assignment	35
5.4.3	Fault memory configuration	36
5.4.4	Interface configuration	37
5.5	Menu "t"	37
5.5.1	Time configuration	37
5.6	Menu "SEt"	38
5.6.1	Function configuration	38
5.7	Measuring value display and history memory	38
6.	Data access using the BMS protocol	40

7. Data access using the Modbus RTU protocol	41
7.1 Reading out the Modbus register from the ISOMETER®	41
7.1.1 Master sends a command to the ISOMETER®	41
7.1.2 ISOMETER® answers the master	42
7.2 Writing to Modbus registers (parameter setting)	42
7.2.1 Master sends a command to the ISOMETER®	42
7.2.2 ISOMETER® answer to the master	43
7.3 Exception code	43
7.3.1 Structure of the exception code	43
8. Modbus register assignment of the ISOMETER®	44
8.1 ISOMETER® device-specific data type	49
8.1.1 Device name	49
8.1.2 Measuring values	50
8.1.2.1 Float = Floating point value of the channels	50
8.1.2.2 AT&T = Alarm type and test type (internal/external)	51
8.1.2.3 R&U = Range and unit	52
8.1.3 Alarm assignment of the relays	53
8.2 Channel descriptions	54
9. IsoData data string	56
10. Technical data	58
10.1 Tabular presentation	58
10.2 Standards, approvals and certifications	64
10.3 Ordering data	64

1. Important information

1.1 How to use this manual



This manual is intended for electrically skilled persons working in electrical engineering and electronics.

Always keep this manual within easy reach for future reference.

To make it easier for you to understand and revisit certain sections in this manual, we have used symbols to identify important instructions and information. The meaning of these symbols is explained below:



DANGER

*This signal word indicates that there is a **high risk** of danger that will result in **death** or **serious injury** if not avoided.*



WARNING

*This signal word indicates a **medium risk of danger** that can lead to **death** or **serious injury** if not avoided.*



CAUTION

*This signal word indicates a **low level risk** that can result in **minor** or **moderate injury or damage to property** if not avoided.*



*This symbol denotes information intended to assist the user in making **optimum use** of the product.*

1.2 Technical support: Service and support

For commissioning and troubleshooting Bender offers you:

1.2.1 First level support

Technical support by phone or e-mail for all Bender products

- Questions concerning specific customer applications
- Commissioning
- Troubleshooting

Telefon: +49 6401 807-760*

Fax: +49 6401 807-259

In Germany only: 0700BenderHelp (Tel. and Fax)

E-mail: support@bender-service.com

1.2.2 Repair service

- Repair, calibration, update and replacement service for Bender products
- Repairing, calibrating, testing and analysing Bender products
- Hardware and software update for Bender devices
- Delivery of replacement devices in the event of faulty or incorrectly delivered Bender devices
- Extended warranty for Bender devices with in-house repair service or replacement device at no extra cost

Telefon: +49 6401 807-780** (technical issues)
+49 6401 807-784**, -785** (sales)

Fax: +49 6401 807-789

E-mail: repair@bender-service.com

1.2.3 Field service

On-site service for all Bender products

- Commissioning, parameter setting, maintenance, troubleshooting for Bender products
- Analysis of the electrical installation in the building (power quality test, EMC test, thermography)
- Training courses for customers

Telefon: +49 6401 807-752**, -762 **(technical issues)
+49 6401 807-753** (sales)

Fax: +49 6401 807-759

E-mail: fieldservice@bender-service.com

Internet: www.bender-de.com

*Available from 7.00 a.m. to 8.00 p.m. 365 days a year (CET/UTC+1)

**Mon-Thurs 7.00 a.m. - 8.00 p.m., Fr 7.00 a.m. - 13.00 p.m.

1.3 Training courses

Bender is happy to provide training regarding the use of test equipment. The dates of training courses and workshops can be found on the Internet at www.bender-de.com -> Know-how -> Seminars.

1.4 Delivery conditions

Bender sale and delivery conditions apply. For software products, the "Softwareklausel zur Überlassung von Standard-Software als Teil von Lieferungen, Ergänzung und Änderung der Allgemeinen Lieferbedingungen für Erzeugnisse und Leistungen der Elektroindustrie" (software clause in respect of the licensing of standard software as part of deliveries, modifications and changes to general delivery conditions for products and services in the electrical industry) set out by the ZVEI (Zentralverband Elektrotechnik- und Elektronikindustrie e.V.) (German Electrical and Electronic Manufacturers' Association) also applies.

Sale and delivery conditions can be obtained from Bender in printed or electronic format.

1.5 Inspection, transport and storage

Inspect the dispatch and equipment packaging for damage, and compare the contents of the package with the delivery documents. In the event of damage in transit, please contact Bender immediately.

The devices must only be stored in areas where they are protected from dust, damp, and spray and dripping water, and in which the specified storage temperatures can be ensured.

1.6 Warranty and liability

Warranty and liability claims in the event of injury to persons or damage to property are excluded if they can be attributed to one or more of the following causes:

Improper use of the device.

- Incorrect mounting, commissioning, operation and maintenance of the device.
- Failure to observe the instructions in this operating manual regarding transport, commissioning, operation and maintenance of the device.
- Unauthorised changes to the device made by parties other than the manufacturer.
- Non-observance of technical data.
- Repairs carried out incorrectly and the use of replacement parts or accessories not approved by the manufacturer.
- Catastrophes caused by external influences and force majeure.
- Mounting and installation with device combinations not recommended by the manufacturer.
- This operating manual, especially the safety instructions, must be observed by all personnel working on the device. Furthermore, the rules and regulations that apply for accident prevention at the place of use must be observed.

1.7 Disposal

Abide by the national regulations and laws governing the disposal of this device. Ask your supplier if you are not sure how to dispose of the old equipment.

The directive on waste electrical and electronic equipment (WEEE directive) and the directive on the restriction of certain hazardous substances in electrical and electronic equipment (RoHS directive) apply in the European Community. In Germany, these policies are implemented through the "Electrical and Electronic Equipment Act" (ElektroG). According to this, the following applies:

- Electrical and electronic equipment are not part of household waste.
- Batteries and accumulators are not part of household waste and must be disposed of in accordance with the regulations.
- Old electrical and electronic equipment from users other than private households which was introduced to the market after 13th August 2005 must be taken back by the manufacturer and disposed of properly.

For more information on the disposal of Bender devices, refer to our homepage at www.bender.de -> Service & support.

2. Safety instructions

2.1 General safety instructions

Part of the device documentation in addition to this manual is the enclosed "Safety instructions for Bender products".

2.2 Work activities on electrical installations



Only skilled persons are permitted to carry out the work necessary to install, commission and run a device or system.



DANGER

Risk of electrocution due to electric shock!

Touching live parts of the system carries the risk of:

- An electric shock
- Damage to the electrical installation
- Destruction of the device

Before installing and connecting the device, make sure that the installation has been de-energised. Observe the rules for working on electrical installations.

If the device is used outside the Federal Republic of Germany, the applicable local standards and regulations must be complied with. The European standard EN 50110 can be used as a guide.

2.3 Intended use

The ISOMETER® of the isoPV425 series monitors the insulation resistance of unearthed AC/DC main circuits (IT systems) with nominal system voltages of 3(N)AC, AC/DC 0 ... 690 V or DC 0 ... 1000 V. DC components existing in 3(N)AC, AC/DC systems do not influence the operating characteristics, when a minimum load current of DC 10 mA flows. A separate supply voltage allows de-energised systems to be monitored as well. The ISOMETER® is always used in conjunction with the AGH420.



To ensure that the ISOMETER® functions correctly, an internal resistance of $\leq 1 \text{ k}\Omega$ must exist between L1/+ and L2/- via the source (e.g. the transformer) or the load.

3. Function

3.1 Device characteristics

- Monitoring for unearthed AC and DC systems with galvanically connected rectifiers or inverters
- Measurement of the mains voltage (RMS) with undervoltage and overvoltage detection
- Measurement of DC voltages system to earth (L+/PE and L-/PE)
- Automatic adaptation to the system leakage capacitance up to 1000 μF
- Automatic device self-test with connection monitoring
- Selectable start-up delay, response delay and delay on release
- Two separately adjustable response value ranges of 1k Ω ... 500 k Ω (Alarm 1, Alarm 2)
- Alarm signalling via LEDs (AL1, AL2), a display and alarm relays (K1, K2)
- N/C operation or N/O operation of the relays selectable
- Measured value indication via multi-functional LCD
- Fault memory can be activated
- RS-485 (galvanically isolated) including the following protocols:
 - BMS interface (Bender measuring device interface) for data exchange with other Bender components
 - Modbus RTU
 - IsoData (for continuous data output)
- Password protection to prevent unauthorised parameter changes

3.2 Functional description

The ISOMETER® measures the insulation resistance R_F and the leakage capacitance C_e between the system to be monitored (L1/+, L2/-) and earth (PE). The RMS value of the mains voltage U_n between L1/+ and L2/-, as well as the DC voltages between L1/+ and earth (U_{L1e}) and between L2/- and earth (U_{L2e}) are also measured.

From a minimum value of the DC system voltage, the ISOMETER® determines the fault location "R %", which shows the distribution of the insulation resistance between conductors L1/+ and L2/-. The distribution is indicated by a positive or negative sign preceding the insulation resistance measurement. The value range of the fault location is $\pm 100\%$:

Display	Description
-100 %	one-sided fault at conductor L2/-
0 %	symmetrical fault
+100 %	one-sided fault at conductor L1/
+	

The partial resistances can be calculated from the total insulation resistance R_F and the fault location (R %) using the following formula:

$$\text{Fault at conductor L1/+} \quad R_{L1F} = (200\% * R_F) / (100\% + R\%)$$

$$\text{Fault at conductor L2/-} \quad R_{L2F} = (200\% * R_F) / (100\% - R\%)$$

Also from a minimum value of the DC system voltage, the ISOMETER® determines the insulation resistance R_{UGF} from the DC voltages U_{L1e} and U_{L2e} . It is an approximate value for one-sided insulation faults and can be used as a trend indicator in cases where the ISOMETER® has to adapt to an R_F and C_e relation that varies considerably.

It is possible to assign the detected fault or the faulty conductor to an alarm relay via the menu. If the values R_F or U_n exceed the response values activated in the "AL" menu, this will be indicated by the LEDs and relays K1 and K2 according to the alarm assignment set in the "out" menu. In addition, the operation of the relay (n.o. / n.c.) can be set and the fault memory "M", activated. If the values R_F or U_n do not exceed their release value (response value plus hysteresis) for the period t_{off} without interruption, the alarm relays will

switch back to their initial position and the alarm LEDs AL1/AL2 stop lighting. If the fault memory is activated, the alarm relays remain in the alarm condition and the LEDs light until the reset button "R" is pressed or the supply voltage is interrupted.

The device function can be tested using the test button "T". Parameters are assigned to the device via the LCD and the control buttons on the front panel; this function can be password-protected. Parameterisation is also possible via the BMS bus, for example by using the BMS Ethernet gateway (COM465IP) or the Modbus RTU.



The isoPV 425 determines the leakage capacitance through an impedance measurement whose frequency is adjusted to the most accurate insulation measured value possible. The measurement signal is affected if it goes through a rectifier or inverter, and this can lead to phase errors that may result in an incorrect leakage capacitance value.

3.2.1 Monitoring the insulation resistance

The two parameters that monitor the insulation resistance, R1 and R2, can be found in the response value menu "AL" (see table in [Chapter 5.3](#)). The value R1 can only be set higher than the value R2. If the insulation resistance R_F reaches or falls below the activated values R1 or R2, an alarm message will be signalled. If R_F exceeds the values R1 or R2 plus the hysteresis value (see the table in [Chapter 5.3.1](#)), the alarm will be cleared.

3.2.2 Undervoltage/overvoltage monitoring

In the response value menu "AL" (see [Chapter 5.3](#)), the parameters (U < and U >) for monitoring the mains voltage can be activated or deactivated. The maximum undervoltage value is limited by the overvoltage value.

The r.m.s. value of the mains voltage is monitored. If the mains voltage U_n reaches, falls below or exceeds the limit values (U < or U >), an alarm will be signalled. If the maximum permissible system voltage set for the ISOMETER® is exceeded, an alarm message will be initiated even when the overvoltage limit value has been deactivated. The alarm will be deleted when the limit values plus hysteresis (see [Chapter 5.3.1](#)) are no longer violated.

3.2.3 Self test/error codes

The integrated self test function checks the function of the insulation monitoring device, and connection monitoring checks the connections to the system to be monitored. The alarm relays are not switched during the self test. This can be changed using the parameter "test" in the alarm assignment (menu "out", [Chapter 5.4.2](#)). During the test, the display indicates "tES".

When malfunctions are detected or connections are missing, the LEDs ON/AL1/AL2 flash. The respective error codes (E.xx) will be indicated on the display and the relay K2 switches.

The relays can be assigned to a device error with the parameter "Err" in the "out" menu in the alarm assignment.

Error codes

If, contrary to expectations, a device error should occur, error codes will appear on the display. Some of these are described below:

Error code	Description
E.01	<p>PE connection error The connections E or KE to earth are interrupted. Action: Check connection, eliminate error. The error code will be erased automatically once the error has been eliminated.</p>
E.02	<p>Connection fault system (L1/+ , L2/-), The internal resistance of the system is too high, the connection L1/+ or L2/- to the system is interrupted or L1/+ and L2/- are connected in reverse polarity to the DC System to be monitored ($U_n < -100\text{ V}$). Action: Check connection, eliminate error. The error code will be erased automatically once the error has been eliminated.</p>
E.05	<p>Measurement technique error/calibration invalid For the current software version</p>
E.07	<p>The maximum permissible system leakage capacitance C_e is exceeded Action: Device not suitable for the existing leakage capacitance: uninstall device.</p>
E.08	<p>Calibration error during device test Action: If the error continues to exist after checking the device connections, there is an error inside the device.</p>

Internal device errors E.xx can be caused by external disturbances or internal hardware errors. If the error message occurs again after restarting the device or after a reset to factory settings (menu item "FAC") , the device must be repaired.

After eliminating the fault, the alarm relays switch back automatically or by pressing the reset button.

The self test can take a few minutes. It can be suppressed for the duration of the device start by setting the parameter in the menu "SEt" to "S.Ct = off". This allows the ISOMETER® to enter measurement mode quickly after connecting the supply voltage.

Automatic self test

The device runs a self test after connecting the power supply and then every 24 hours (selectable: off, 1 h, 24 h).

Manual self test

A self test is initiated by pressing the test button "T" for a period greater than 1.5 s. While pressing the internal test button, all display elements available for this device are shown.

Connection monitoring

Connection monitoring, activated by the self test, checks the connections of terminals E and KE to the protective earth conductor (PE).

When an error is detected, the message device error (Err) will be signalled and the error code E.01 appears on the display.

The system connection monitoring is used to check the connection of terminals L1/+ and L2/- to the system to be monitored. When an interruption or a high-resistance connection between L1/+ and L2/- is detected via the internal resistance of the system, the device error (Err) will be signalled and the error code E.02 appears on the display. Since a test of the system connection may take considerable time due to system disturbances or may even provide incorrect results, the system connection monitoring can be disconnected using the parameter "nEt" in the "SEt" menu.

3.2.4 Malfunction

In addition to the self test described above, several functions in the insulation monitoring device are continuously checked during operation. If a fault is detected, the device error (Err) will be signalled, the error code E.xx appears on the display as an identifier for the error type xx and the LEDs ON/AL1/AL2 will flash. If the error occurs again after restarting the device or after a reset to factory settings, then contact Bender Service.

3.2.5 Signalling assignment of the alarm relays K1/K2

The messages: device error; insulation fault; insulation impedance fault; undervoltage/overvoltage fault; device test; or device start can be assigned to the alarm relays via the "out" menu. An insulation fault is indicated by the messages +R1, -R1, +R2 and -R2. Messages +R1 and +R2 indicate an insulation fault assigned to conductor L1/+, and the messages -R1 and -R2 indicate an insulation fault assigned to conductor L2/-. If an assignment is not possible, for example in the event of a symmetrical insulation fault, the messages corresponding to + and - are shown together.

The message "test" indicates a self test.

The message "S.AL" indicates a so-called "device start with alarm". After connecting to the supply voltage and setting the parameter value to "S.AL = on", the ISOMETER® starts with the insulation measurement value $R_F = 0 \Omega$ and sets all activated alarms.

The alarms will be cleared only when the measured values are up-to-date and no thresholds are exceeded. In the factory setting "S.AL = off", the ISOMETER® starts without an alarm.

It is recommended that the value set for the "S.AL" parameter value is identical for both relays.

3.2.6 Measuring and response times

The measuring time is the period essential for the detection of the measuring value. The measuring time is reflected in the operating time t_{ae} .

The measuring time for the insulation resistance value is mainly determined by the required measuring pulse duration, which depends on the insulation resistance and leakage capacitance of the system to be monitored. The measuring pulse is produced by the measuring pulse generator integrated in the ISOMETER®. The measuring times for C_{er} , U_{L1e} , U_{L2e} and R % are synchronous. System disturbances may lead to extended measuring times. In contrast, the time for the system voltage measurement U_n is independent and considerably shorter.

Total response time t_{an}

The total response time t_{an} is the sum of the operating time t_{ae} and the response delay time t_{on} .

Operating time t_{ae}

The operating time t_{ae} is the time required by the ISOMETER® to determine the measuring value. The insulation resistance measuring value depends on the insulation resistance and the leakage capacitance. High leakage capacitances and system interferences lead to longer operating times.

Response delay t_{on}

The response delay t_{on} is set uniformly for all messages in the menu "t" using the parameter "ton". This delay time can be used for interference suppression in the case of short measuring times. An alarm will only be signalled when a threshold value of the respective measuring value is exceeded for the period of t_{on} without interruption. Every time the threshold value is violated within the time t_{on} , the response delay "ton" restarts once again.

Every alarm message listed in the alarm assignment has its own timer for t_{on} .

Delay on release t_{off}

The delay on release t_{off} can be set uniformly for all messages in the menu "t" using the parameter "toff".

An alarm will continuously be signalled until the threshold value of the respective measuring value is not exceeded (including hysteresis) for the period of t_{off} without interruption. Each time the threshold value is not exceeded for the period of t_{off} , the delay on release t_{off} restarts again. Every alarm message listed in the alarm assignment has its own timer for t_{off} .

Start-up delay t

After connection to the supply voltage U_S , the alarm indication is suppressed for the preset time (0...10 s) specified for parameter "t".

3.2.7 Password protection (on, OFF)

If password protection has been activated (on), settings can only be made subject to the correct password being entered (0...999).

3.2.8 Factory setting FAC

Activating the factory settings will reset all modified settings - with the exception of the interface parameters - to the default values used when the device was delivered.

3.2.9 External, combined test or reset button T/R

Reset= Press the external button < 1.5 s

Reset followed by a test= Press the external button > 1.5 s

Stop measuring function = Press and hold the external button

The stop function can also be triggered via an interface command and in this case it can only be reset via the interface. Only one ISOMETER® may be controlled via a test/reset button. A galvanic parallel connection of several test or reset inputs for testing multiple insulation monitoring devices is not allowed.

3.2.10 Fault memory

The fault memory can be activated or deactivated with the parameter "M" in the menu "out". When the fault memory is activated, all pending LED and alarm messages remain available until they are deleted by using the reset button (internal) or if the supply voltage U_s is turned off.

3.2.11 History memory HiS

When the first error occurs after clearing the history memory, all measured values (that are marked in the table in [Chapter 5.7](#)) are saved in the history memory. This data can be read out using the "HiS" menu item. In order to be able to record a new data record, the history memory must first be cleared via the menu using "Clr".

3.2.12 Interface/protocols

The ISOMETER® uses the serial hardware interface RS-485 with the following protocols:

- **BMS**

The BMS protocol is an essential component of the Bender measuring device interface (BMS bus protocol). Data is transferred using ASCII characters.

- **Modbus RTU**

Modbus RTU is an application layer messaging protocol and it provides Master/Slave communication between devices that are connected together via bus systems and networks. Modbus RTU messages have a 16-bit CRC (Cyclic Redundant Checksum), which guarantees reliability.

- **IsoData**

The ISOMETER® continuously sends an ASCII data string with a cycle of approximately 1 second. Communication with the ISOMETER® within this mode is not possible and no additional transmitter may be connected to the RS-485 bus cable. The ASCII data string for the ISOMETER® is described in [Chapter 9](#).

The device address, baud rate and parity for the interface protocols are configured in the "out" menu.



With "Adr = 0", the menu entries baud rate and parity are not shown in the menu and the IsoData protocol is activated. With a valid bus address (i.e. not equal to 0), the menu item "baud rate" is displayed in the menu. The parameter value "---" for the baud rate indicates the activated BMS protocol. In this event, the baud rate for the BMS protocol is set to 9600 baud. If the baud rate is set unequal to "---", the modbus protocol is activated with a configurable baud rate .

4. Installation, connection and commissioning



DANGER

Risk of electric shock!

Touching uninsulated live conductors can result in death or serious injury. Therefore avoid any physical contact with active conductors and ensure compliance with the regulations for working on electrical installations.

4.1 Installation

- **DIN rail mounting:**

Snap the mounting clip at the rear of the device onto the DIN rail so that it sits securely.

- **Screw fixing:**

Use a tool to position the rear mounting clips so that they project beyond the enclosure (a second mounting clip is required, see ordering information). Fix the device with two M4 screws, see the following sketch.

The dimension diagram, and sketches outlining how the device can be screw mounted and the push-wire terminal connection are shown on the following page.

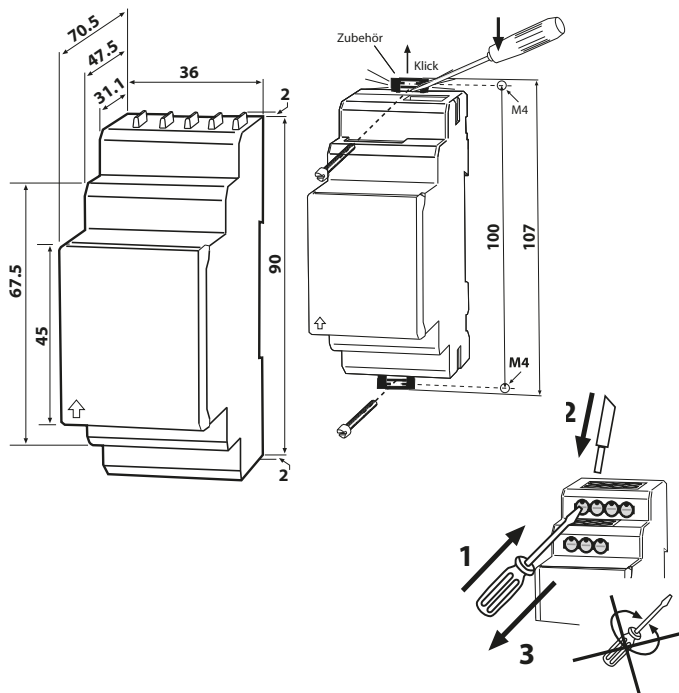

All dimensions in mm

The front plate cover can be opened at the lower part marked with an arrow.

4.2 Connection

Connect the terminals A1 and A2 to the supply voltage according to IEC 60364-4-43, i.e. the connections are to be protected against a short-circuit by means of a protective device (a 6 A fuse is recommended).

Devices for protection against a short circuit in conformity with IEC 60364-4-43 for the coupling of terminals L1/L2 to the IT system to be monitored can be omitted if the wiring is carried out in such a manner as to reduce the risk of a short circuit to a minimum.

Connect the device as illustrated in the wiring diagram below:

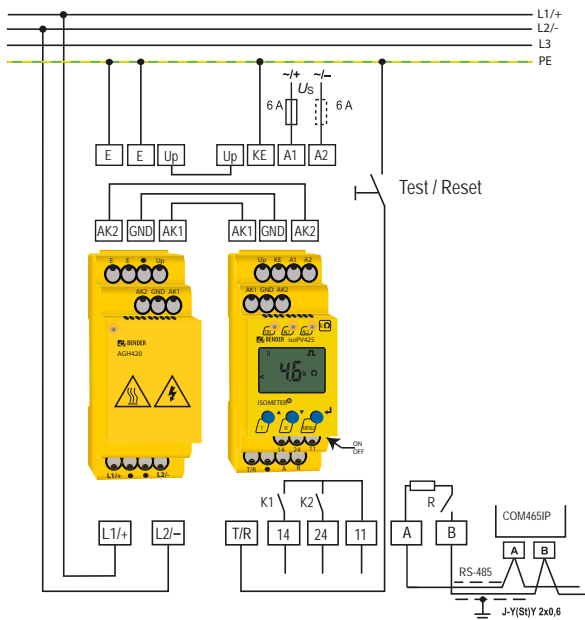

CAUTION

Danger from touching hot surfaces!

If the AGH420 is operated at system voltages > 800 V, the temperature of the enclosure may exceed 60 °C.

Once the device is connected to the mains voltage, avoid touching the surfaces of the device.

For details about the conductor cross sections required for wiring, refer to the technical data on [Page 58](#).

Wiring diagram legend:

Terminal	Connections
A1, A2	Connection to the supply voltage via a fuse: If supplied from an IT system, both lines have to be protected by a fuse.*
E, E, KE	Connect each terminal separately to PE: The same wire cross section as for A1, A2 is to be used.
L1/+, L2/-	Connection to the 3(N)AC, AC or DC system to be monitored
Up, AK1, GND, AK2	Connect the terminals of the AGH420 to the corresponding terminals of the ISOMETER®.
T/R	Connection for external combined test and reset button
11, 14	Connection to alarm relay K1
11, 24	Connection to alarm relay K2
A, B	RS-485 communication interface with selectable terminating resistance



*** For UL applications:**

Only use 60/75°C copper lines!

UL and CSA applications require the supply voltage to be protected via 5 A fuses.

4.3 Commissioning

1. Check that the ISOMETER® is properly connected to the system to be monitored.

2. **Connecting supply voltage to the ISOMETER®**

The device carries out a calibration, a self test and adjusts itself to the IT system to be monitored. When high system leakage capacitances are involved, this procedure may take up to 4 minutes. The standard display then appears showing the present insulation resistance, e.g.:

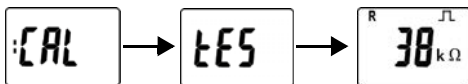

The pulse symbol signals an error-free update of the resistance and capacitance measurement values. If the measurement value cannot be updated due to disturbances, the pulse symbol will be hidden.

3. **Start a manual self test** by pressing the test button "T". Whilst the test button is pressed and held down, all display elements available for this device are shown. During the test, the "tES" symbol flashes. Any internal malfunctions detected are shown on the display as error codes (see [Page 18](#)). The alarm relays are not checked during the test (factory setting). The setting can be changed in the "out" menu, so that the relays switch to the alarm state during the manual self test.

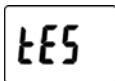

4. **Checking factory settings for suitability**

Are the settings suitable for the installation to be monitored?



The list of factory settings are shown in table in [Chapter 5](#).

5. **Checking the function using a genuine insulation fault**

The ISOMETER® in the system being monitored can be checked using, for example a suitable resistance to earth.

5. Operation of the device





The menu structure is illustrated schematically on the following pages. After pressing the "MENU" button for > 1.5 seconds, the first menu "AL" menu item appears. Use ▲▼ and ↵ (Enter) buttons for navigation and settings.

	<p>Up and down button:</p> <ul style="list-style-type: none"> - navigate up or down in the menu settings - increase or decrease values
<p>MENU</p> 	<p>Pressing the MENU/Enter button for more than 1.5 s:</p> <ul style="list-style-type: none"> - Starts menu mode <p>or</p> <ul style="list-style-type: none"> - when the device already is in menu mode: Exit menu item (Esc). Any recent changes will not be saved <p>Pressing the MENU/Enter button for less than 1.5 s:</p> <ul style="list-style-type: none"> - Confirms menu selection <p>or</p> <ul style="list-style-type: none"> - confirms modified value

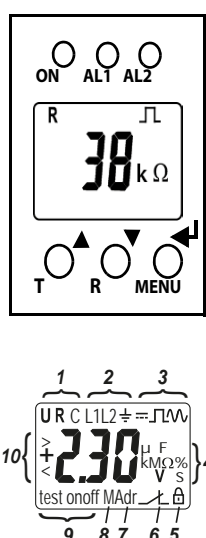

The areas of the display that can be configured flash!

5.1 Display elements in use

Device front/display	Function	
	ON AL1 AL2	green - on yellow - alarm yellow - alarm <i>Assignment according to table on Page 35</i>
	 T	Up button Test button (press > 1.5 s)
	 R	Down button Reset button (press > 1.5 s)
		ENTER
	MENU	MENU button (press > 1.5 s)
	1	U : Mains voltage R : Insulation resistance C : Leakage capacitance
	2	Monitored conductor
	3	= : Voltage type DC  : Disturbance-free measurement value update ~ : Voltage type AC
	4	Measured values and units
	5	Password protection is activated.
6	In menu mode, the operating mode of the respective alarm relay is displayed.	
7	Communication interface With measured value: isoData operation	
8	The fault memory is activated.	
9	Status indicators	
10	Identifier for response values and response value violation	

5.2 Menu structure

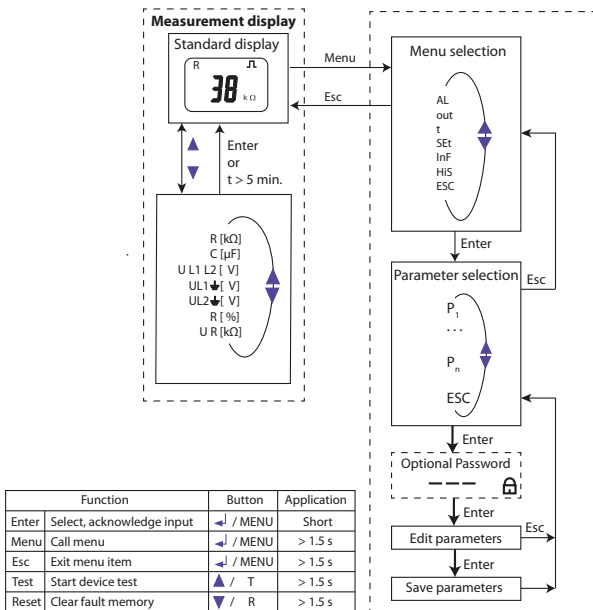

Menu item	Parameters
AL	Query and set response values
out	Configure fault memory, alarm relays and interface
t	Setting delay times and self-test cycles
SEt	Setting device control parameters
InF	Querying software version
HiS	Querying and clearing the history memory
ESC	Go to the next higher menu level

5.3 Menu "AL"

5.3.1 Response value setting

The two parameters that monitor the insulation resistance, R1 and R2, can be found in the response value menu "AL". The value R1 can only be set higher than the value R2. If the insulation resistance R_F reaches or falls below the activated values R1 or R2, then this leads to an alarm message. If R_F exceeds the values R1 or R2 plus the hysteresis value (see table below), the alarm will be cleared.

Also in the response value menu "AL" the parameters (U < and U >) for monitoring the mains voltage can be activated or deactivated. The maximum undervoltage value is limited by the overvoltage value.

Display	Activation		Setting value			Description
	FAC	Cs	Value range	FAC	Cs	
R1 <			R2 ... 500	10	kΩ	Pre-alarm value R_{an1} Hys. = 25 %/min. 1 kΩ
R2 <			1 ... R1	5	kΩ	Alarm value R_{an2} Hys. = 25 %/min. 1 kΩ
U <	off		30 ... "U>"	30	V	Alarm value undervoltage Hys. = 5 %/min. 5 V
U >	off		"U<" ... 1.15 k	1000	V	Alarm value overvoltage Hys. = 5 %/min. 5 V

FAC = Factory setting; **Cs** = User settings

5.4 Menu "out"

5.4.1 Configuration of the relay operating mode



Relay K1			Relay K2			Description
Display	FAC	Cs	Display	FAC	Cs	
 1	n.c.		 2	n.c.		Operating mode of the relay n.c./n.o.

FAC = Factory setting; **Cs** = User settings

5.4.2 Relay alarm assignment "r1" and "r2" and LED assignment

In the alarm assignment, each alarm is assigned to the respective relay with the setting "on". The LED indication is directly assigned to the alarms and is not related to the relays.

In the event of an unsymmetrical insulation fault, only the alarm corresponding to the assigned conductor (L1/+ or L2/-) will be displayed. Otherwise, the messages for L1/+ and L2/- are shown together.

K1 "r1"			K2 "r2"			LEDs			Alarm description
Display	FAC	Cs	Display	FAC	Cs	ON	AL1	AL2	
 1 Err	off		 2 Err	on		⊙	⊙	⊙	Device error E.xx
r1 +R1 < Ω	on		r2 +R1 < Ω	off		●	●	○	Pre-alarm R1 Fault R_F at L1/+
r1 -R1 < Ω	on		r2 -R1 < Ω	off		●	●	○	Pre-alarm R1 Fault R_F at L2/-
r1 +R2 < Ω	off		r2 +R2 < Ω	on		●	○	●	Alarm R2 Fault R_F at L1/+
r1 -R2 < Ω	off		r2 -R2 < Ω	on		●	○	●	Alarm R2 Fault R_F at L2/-
r1 U < V	off		r2 U < V	on		●	○	⊙	Alarm U_n Undervoltage

K1 "r1"			K2 "r2"			LEDs			Alarm description
Display	FAC	Cs	Display	FAC	Cs	ON	AL1	AL2	
r1 U > V	off		r2 U > V	on		●	◎	○	Alarm U_n Overvoltage
r1 test	off		r2 test	off		●	●	●	Manually started device test
r1 S.AL	off		r2 S.AL	off		●	●	●	Device start with alarm

FAC = Factory setting; **Cs** = User settings
 ○: LED off ◎: LED flashes ●: LED on

5.4.3 Fault memory configuration

Display	FAC	Cs	Description
M	off		Memory function for alarm messages (fault memory)

FAC = Factory setting; **Cs** = User settings

5.4.4 Interface configuration

Display	Setting value				Description
	Value range	FAC	Cs		
Adr	0 / 3 ... 90	3	()	Bus adr.	Adr = 0 deactivates BMS as well as Modbus and activates isoData with continuous data output (115k2, 8E1)
Adr 1	--- / 1.2k ... 115k	"---"	()	Baud rate	"---" : BMS bus (9k6, 7E1) "1.2k" ... "115k" --> Modbus (variable, variable)
Adr 2	8E1 8o1 8n1	8E1	()	Modbus	8E1 - 8 data bits even parity, 1 stop bit 8o1 - 8 data bits odd parity, 1 stop bit 8n1 - 8 data bits no parity, 1 stop bit

FAC = Factory setting; **Cs** = User settings
() = User setting that is not modified by FAC.

5.5 Menu "t"

5.5.1 Time configuration

Display	Setting value				Description
	Value range	FAC	Cs		
t	0 ... 10	0		s	Device start-up delay
ton	0 ... 99	0		s	Response delay K1 and K2
toff	0 ... 99	0		s	Delay on release K1 and K2
test	OFF / 1 / 24	24		h	Repetition time device test

FAC = Factory setting; **Cs** = User settings

5.6 Menu "SEt"



5.6.1 Function configuration

Display	Activation		Settings			Description
	FAC	Cs	Value range	FAC	Cs	
	off		0 ... 999	0		Password for parameter setting
nEt	on					Monitoring system connection during device test
S.Ct	on					Device test during device start
FAC						Restore factory settings
SYS						For Bender Service only

FAC = Factory setting; **Cs** = User settings

5.7 Measuring value display and history memory

All other measuring value displays switch to the standard display (insulation resistance) after a maximum of 5 minutes. The pulse symbol indicates the current measured value. If this symbol does not appear, then the measurement is still running and the latest valid measured value will be displayed. The symbols < or > will additionally be displayed with the measured value when a response value has been reached or exceeded, or the measured value is below or above the measuring range.

HiS	Display	Description
✓	± R kΩ 	Insulation resistance R_F 1 kΩ ... 1 MΩ Resolution 1 kΩ
✓	C μF 	Leakage capacitance C_e 1 μF ... 1105 μF Resolution 1 μF

HiS	Display	Description
✓	$\sim \pm U_{L1 L2} \text{ V}$	Mains voltage L1 - L2 U_n $0 \text{ V}_{\text{RMS}} \dots 1.20 \text{ kV}_{\text{RMS}}$ Resolution $1 \text{ V}_{\text{RMS}} / 10 \text{ V}_{\text{RMS}}$
✓	$\pm U_{L1} \text{ } \perp \text{ } = \text{V}$	Mains voltage L1/+ - PE U_{L1e} $0 \text{ V}_{\text{DC}} \dots \pm 1.20 \text{ kV}_{\text{DC}}$ Resolution $1 \text{ V}_{\text{DC}} / 10 \text{ V}_{\text{DC}}$
✓	$\pm U_{L2} \text{ } \perp \text{ } = \text{V}$	Mains voltage L2/- - PE U_{L2e} $0 \text{ V}_{\text{DC}} \dots \pm 1.20 \text{ kV}_{\text{DC}}$ Resolution $1 \text{ V}_{\text{DC}} / 10 \text{ V}_{\text{DC}}$
✓	$\pm R \text{ } \%$	Fault location in % $-100 \% \dots +100 \%$ Indication only from $U_n \geq 100 \text{ V}_{\text{DC}}$ $R_{L1F} = (200 \% * R_F) / (100 \% + x \%)$ $R_{L2F} = (200 \% * R_F) / (100 \% - x \%)$
-	$U_R = \text{k}\Omega \text{ } \square \text{ } \square$	Insulation resistance R_{UGF} $1 \text{ k}\Omega \dots 1 \text{ M}\Omega$ Resolution $1 \text{ k}\Omega$ R_{UGF} is an approximate value for asymmetrical insulation faults and can be used as a trend indicator with short measuring times. It is determined by the DC mains voltage ($> 50 \text{ V}$) and is only correct in the event of one-sided insulation faults. If there are simultaneous insulation faults at L1/+ and L2/- the value is indicated as a too high impedance.

✓ : The measured value can be displayed in the history memory.

6. Data access using the BMS protocol

The BMS protocol is an essential component of the Bender measuring device interface (BMS bus protocol). ASCII characters are used for the data transfer.

BMS channel no.	Operation value	Alarm
1	R_F	Pre-alarm R1
2	R_F	Alarm R2
3	C_e	---
4	U_n	Undervoltage
5	U_n	Overvoltage
6	---	Connection fault earth (E.01)
7	---	Connection fault system (E.02)
8	---	All other device faults (E.xx)
9	Fault location [%]	---
10	U_{L1e}	---
11	U_{L2e}	---
12	Update counter	---
13	R_{UGF}	---
14	---	---
15	---	---

7. Data access using the Modbus RTU protocol

Requests to the ISOMETER® can be made using the function code 0x03 (read multiple registers) or the command 0x10 (write multiple registers). The ISOMETER® generates a function-related answer and sends it back.

7.1 Reading out the Modbus register from the ISOMETER®

The required Words of the process image can be read from the ISOMETER® "Holding registers" using the function code 0x03. For this purpose, the start address and the number of the registers to be read have to be entered. Up to 125 Words (0x7D) can be read by one single request.

7.1.1 Master sends a command to the ISOMETER®

In the following example, the master addresses the ISOMETER® with address 3 and the requests the contents of register 1003. The register contains the channel description of measuring channel 1.

Byte	Name	Example
Byte 0	ISOMETER® Modbus address	0x03
Byte 1	Function code	0x03
Byte 2, 3	Start address	0x03EB
Byte 4, 5	Number of registers	0x0001
Byte 6, 7	CRC16 Checksum	0xF598

7.1.2 ISOMETER® answers the master

Byte	Name	Example
Byte 0	ISOMETER® Modbus address	0x03
Byte 1	Function code	0x03
Byte 2	Number of data bytes	0x02
Byte 3, 4	Data	0x0047
Byte 7, 8	CRC16 Checksum	0x81B6

7.2 Writing to Modbus registers (parameter setting)

Registers in the device can be modified with the Modbus command 0x10 (set multiple registers). Parameter registers are available from address 3000. The content of the register is listed in the table on [Page 45](#).

7.2.1 Master sends a command to the ISOMETER®

In this example, the master addresses the ISOMETER® with address 3 and requests that the content of the register with address 3003 is set to 2.

Byte	Name	Example
Byte 0	ISOMETER® Modbus address	0x03
Byte 1	Function code	0x10
Byte 2, 3	Start register	0x0BBB
Byte 4, 5	Number of registers	0x0001
Byte 6	Number of data bytes	0x02
Byte 7, 8	Data	0x0002
Byte 9, 10	CRC16 Checksum	0x9F7A

7.2.2 ISOMETER® answer to the master

Byte	Name	Example
Byte 0	ISOMETER® Modbus address	0x03
Byte 1	Function code	0x10
Byte 2, 3	Start register	0x0BBB
Byte 4, 5	Number of registers	0x0001
Byte 6, 7	CRC16 Checksum	0x722A

7.3 Exception code

If a request cannot be answered for whatever reason, the ISOMETER® will send a so-called exception code with which possible faults can be narrowed down.

Exception code	Description
0x01	Function not allowed
0x02	Data access not allowed
0x03	Data value not allowed
0x04	Internal fault
0x05	Acknowledgement of receipt (answer will be time-delayed)
0x06	Request not accepted (repeat request, if necessary)

7.3.1 Structure of the exception code

Byte	Name	Example
Byte 0	ISOMETER® Modbus address	0x03
Byte 1	Function code (0x03) + 0x80	0x83
Byte 2	Data (exception code)	0x04
Byte 3, 4	CRC16 Checksum	0xE133

8. Modbus register assignment of the ISOMETER®

Depending on the device status, the information in the registers is either: the measured value without alarm; the measured value with alarm 1; the measured value with alarm 2; or only the device fault.

Register	Measured value			Device fault
	Without alarm	Alarm 1	Alarm 2	
1000 to 1003	R_F Insulation fault (71) [no alarm]	R_F Insulation fault (1) [prewarning]	R_F Insulation fault (1) [alarm]	--- Connection earth (102) [Device fault]
1004 to 1007	---	---	---	---
1008 to 1011	U_n Voltage (76) [no alarm]	U_n Undervoltage (77) [alarm]	U_n Overvoltage (78) [alarm]	--- Connection to system (101) [device fault]
1012 to 1015	C_e System leakage capacitance (82) [no alarm]	---	---	---
1016 to 1019	U_{L1e} Voltage (76) [no alarm]	---	---	---
1020 to 1023	U_{L2e} Voltage (76) [no alarm]	---	---	---

Register	Measured value			Device fault
	Without alarm	Alarm 1	Alarm 2	
1024 to 1027	Fault location in % --- (1022) [no alarm]	---	---	---
1028 to 1031	R_{UGF} Insulation fault (71) [no alarm]	---	---	---
1032 to 1035	Measured value update counter --- (1022) [no alarm]	---	---	--- Device fault (115) [Device fault]

() = Channel description code (refer to [Chapter 8.2](#))

[] = Alarm type (refer to [Chapter 8.1.2.2](#))

Register	Property	Description	Format	Unit	Value range
3000	RW	Reserved	---	---	---
3001	RW	Reserved	---	---	---
3002	RW	Reserved	---	---	---
3003	RW	Reserved	---	---	---
3004	RW	Reserved	---	---	---
3005	RW	Pre-alarm value resistance meas- urement "R1"	UINT 16	kΩ	R2 ... 500
3006	RW	Reserved	---	---	---

Register	Property	Description	Format	Unit	Value range
3007	RW	Alarm value resistance measurement "R2"	UINT 16	kΩ	1 ... R1
3008	RW	Activation alarm value undervoltage "U<"	UINT 16	---	0 = Inactive 1 = Active
3009	RW	Alarm value undervoltage	UINT 16	V	30 ... U>
3010	RW	Activation alarm value overvoltage "U>"	UINT 16	---	0 = Inactive 1 = Active
3011	RW	Alarm value Overvoltage "U >"	UINT 16	V	U< ... 1150k
3012	RW	Memory function for alarm messages (Fault memory) "M"	UINT 16	---	0 = Inactive 1 = Active
3013	RW	Operating mode of relay 1 "r1"	UINT 16	---	0 = n.o. 1 = n.c.
3014	RW	Operating mode of relay 2 "r2"	UINT 16	---	0 = n.o. 1 = n.c.
3015	RW	Bus address "Adr"	UINT 16	---	0 / 3 ... 90

Register	Property	Description	Format	Unit	Value range
3016	RW	Baud rate "Adr 1"	UINT 16	---	0 = BMS 1 = 1.2 k 2 = 2.4 k 3 = 4.8 k 4 = 9.6 k 5 = 19.2 k 6 = 38.4 k 7 = 57.6 k 8 = 115.2 k
3017	RW	Parity "Adr 2"	UINT 16	---	0 = 8N1 1 = 8O1 2 = 8E1
3018	RW	Start-up delay "t" during device start	UINT 16	s	0 ... 10
3019	RW	Response delay "ton" for relays K1 and K2	UINT 16	s	0 ... 99
3020	RW	Delay on release "toff" for relays K1 and K2	UINT 16	s	0 ... 99
3021	RW	Repetition time "test" for auto- matic device test	UINT 16	---	0 = OFF 1 = 1 2 = 24
3022	RW	Reserved	---	---	---
3023	RW	Reserved	---	---	---
3024	RW	Test of the system connection dur- ing device test "nEt"	UINT 16	---	0 = Inactive 1 = Active

Register	Property	Description	Format	Unit	Value range
3025	RW	Device test during device start "S. Ct"	UINT 16	---	0 = Inactive 1 = Active
3026	RW	Request stop mode (0 = deactivate device)	UINT 16	---	0 = Stop 1 = ---
3027	RW	Alarm assignment of relay 1 "r1"	UINT 16	---	Bit 15 ... Bit 0
3028	RW	Alarm assignment of relay 2 "r2"	UINT 16	---	Bit 15 ... Bit 0
8003	WO	Factory setting for all parameters	UINT 16	---	0x6661 "fa"
8004	WO	Factory setting only for parameters resettable by FAC	UINT 16	---	0x4653 "FS"
8005	WO	Start device test	UINT 16	---	0x5445 "TE"
8006	WO	Clear fault memory	UINT 16	---	0x434C "CL"
9800 to 9809	RO	Device name	UNIT 16 (ASCII) - refer to Chapter 8.1.1	---	---
9820	RO	Software ID number	UINT 16	---	
9821	RO	Software version number	UINT 16	---	

Register	Property	Description	Format	Unit	Value range
9822	RO	Software version: year	UINT 16		
9823	RO	Software version: Month	UINT 16		
9824	RO	Software version: Day	UINT 16		
9825	RO	Modbus driver ver- sion	UINT 16		

RW = Read/Write; RO = Read Only; WO = Write Only

8.1 ISOMETER® device-specific data type

8.1.1 Device name

The data format of the device name is specified below.

Word 0x00	0x01	0x02	0x03	-----	0x08	0x09
10 Words in total Each Word contains two ASCII characters						

8.1.2 Measuring values

Each measuring value is available as a channel and consists of 8 bytes (4 registers). The first measuring value register address is 1000. The structure of a channel is always identical. Content and number depend on the device. The structure of a channel is shown with the example of channel 1:

1000		1001		1002		1003	
HiByte	LoByte	HiByte	LoByte	HiByte	LoByte	HiByte	LoByte
Floating point value (Float)				Alarm type and test type (AT&T)	Range and unit (R&U)	Channel description	

8.1.2.1 Float = Floating point value of the channels

Bit	0x00																0x01																						
	HiByte								LoByte								HiByte								LoByte														
31								24								16								8								0							
	S	E	E	E	E	E	E	E	E	M	M	M	M	M	M	M	M	M	M	M	M	M	M	M	M	M	M	M	M	M	M								

Presentation of the bit order for processing analogue measuring values according to IEEE 754

S = Sign

E = Exponent

M = Mantissa

8.1.2.2 AT&T = Alarm type and test type (internal/external)

Bit	7	6	5	4	3	2	1	0	Description
	External test	Internal test	Reserved	Reserved	Reserved	Alarm	Error		
Alarm type	X	X	X	X	X	0	0	0	No alarm
	X	X	X	X	X	0	0	1	Prewarning
	0	0	X	X	X	0	1	0	Device error
	X	X	X	X	X	0	1	1	Reserved
	X	X	X	X	X	1	0	0	Warning
	X	X	X	X	X	1	0	1	Alarm
	X	X	X	X	X	1	1	0	Reserved
	X	X	X	X	X	Reserved
	X	X	X	X	X	1	1	1	Reserved
Test	0	0	X	X	X	X	X	X	No test
	0	1	X	X	X	X	X	X	Internal test
	1	0	X	X	X	X	X	X	External test

The alarm type is coded by bits 0 to 2. Bits 3, 4 and 5 are reserved and always have the value 0. Bit 6 or 7 is usually set when an internal or external test has been completed. Other values are reserved. The complete byte is calculated from the sum of the alarm type and the test type.

8.1.2.3 R&U = Range and unit

Bit	7	6	5	4	3	2	1	0	Description
Unit	-	-	-	0	0	0	0	0	Invalid (init)
	-	-	-	0	0	0	0	1	No unit
	-	-	-	0	0	0	1	0	Ω
	-	-	-	0	0	0	1	1	A
	-	-	-	0	0	1	0	0	V
	-	-	-	0	0	1	0	1	%
	-	-	-	0	0	1	1	0	Hz
	-	-	-	0	0	1	1	1	Baud
	-	-	-	0	1	0	0	0	F
	-	-	-	0	1	0	0	1	H
	-	-	-	0	1	0	1	0	°C
	-	-	-	0	1	0	1	1	°F
	-	-	-	0	1	1	0	0	Second
	-	-	-	0	1	1	0	1	Minute
	-	-	-	0	1	1	1	0	Hour
-	-	-	0	1	1	1	1	Day	
-	-	-	1	0	0	0	0	Month	
Range of validity	0	0	X	X	X	X	X	X	Actual value
	0	1	X	X	X	X	X	X	The actual value is lower
	1	0	X	X	X	X	X	X	The actual value is higher
	1	1	X	X	X	X	X	X	Invalid value

- The units of bits 0 to 4 are coded.
- Bits 6 and 7 describe the validity range of a value.
- Bit 5 is reserved.

The complete byte is calculated from the sum of the unit and the range of validity.

8.1.3 Alarm assignment of the relays

Several alarms can be assigned to each relay. For the assignment of each relay, a 16-bit register is used with the bits described below. The following table applies to relay 1 and relay 2, in which "x" stands for the relay number. A set bit activates the specified function.

Bit	Display indication	Description
0	Reserved	When reading, always 0 When writing, any value
1	 x Err	Device error E.xx
2	rx +R1 < Ω	Pre-alarm R1 Fault R_F at L1/+
3	rx -R1 < Ω	Pre-alarm R1 Fault R_F at L2/-
4	rx +R2 < Ω	Alarm R2 Fault R_F at L1/+
5	rx -R2 < Ω	Alarm R2 Fault R_F at L2/-
6	rx U < V	Alarm message U_n Undervoltage
7	rx U > V	Alarm message U_n Overvoltage
8	rx test	Manually started self test
9	S.AL	Device start with alarm
10	Reserved	When reading, always 0 When writing, any value
11	Reserved	When reading, always 0 When writing, any value
12	Reserved	When reading, always 0 When writing, any value

Bit	Display indication	Description
13	Reserved	When reading, always 0 When writing, any value
14	Reserved	When reading, always 0 When writing, any value
15	Reserved	When reading, always 0 When writing, any value

8.2 Channel descriptions

Value	Measured value description/alarm message operating message	Note
0		
1 (0x01)	Insulation fault	
71 (0x47)	Insulation fault	Insulation resistance in Ω
76 (0x4C)	Voltage	Measured value in V
77 (0x4D)	Undervoltage	
78 (0x4E)	Overvoltage	
82 (0x52)	Capacitance	Measured value in F
86 (0x56)	Insulation fault	Impedance
101 (0x65)	Connection to system	
102 (0x66)	Connection to earth	
115 (0x73)	Device error	Fault ISOMETER®
129 (0x81)	Device error	
145 (0x91)	Own address	

To convert parameter data, data type descriptions are required.
Text representation is not necessary in this case.

Value	Description of parameters
1023 (0x3FF)	Parameter/measured value invalid. The menu item of this parameter is not displayed.
1022 (0x3FE)	No measured value/no message
1021 (0x3FD)	Measured value/parameter inactive
1020 (0x3FC)	Measured value/parameter only temporarily inactive (e.g. while transmitting a new parameter). Indication in the menu "...".
1019 (0x3FB)	Parameter/measured value (value) unit not displayed
1018 (0x3FA)	Parameter (code selection menu) unit not displayed
1017 (0x3F9)	String max. 18 characters (e.g. device type, variant, ...)
1016 (0x3F8)	
1015 (0x3F7)	Time
1014 (0x3F6)	Date: Day
1013 (0x3F5)	Date: Month
1012 (0x3F4)	Date: Year
1011 (0x3F3)	Register address (unit not displayed)
1010 (0x3F2)	Time
1009 (0x3F1)	Factor multiplication [*]
1008 (0x3F0)	Factor division [/]
1007 (0x3EF)	Baud rate

9. IsoData data string

In IsoData mode, the ISOMETER® continuously sends the whole data string with a cycle time of approximately 1 second. Communication with the ISOMETER® in this mode is not possible and no additional sender may be connected via the RS-485 bus cable.

IsoData is activated in the menu "out" : menu item "Adr" when it has been set to Adr = 0. In this event, the symbol "Adr" flashes on the measuring value display.

String	Description
!;	Start symbol
v;	Insulation fault location ' ' / '+' / '-'
1234, 5;	Insulation resistance R_F [k Ω]
1234;	Leakage capacitance C_e [μ F]
1234, 5;	Reserved
+1234;	Mains voltage U_n [V _{RMS}] Mains voltage type: AC or unknown: ' ' DC: '+' / '-'
+1234;	Mains voltage U_{L1e} [V _{DC}]
+1234;	Mains voltage U_{L2e} [V _{DC}]
+123;	Insulation fault location -100 ... +100 [%]
1234, 5;	Approximate asymmetrical insulation resistance R_{UGF} [k Ω]

String	Description
1234;	<p>Alarm message [hexadecimal] (without leading "0x")</p> <p>Using the OR function, the alarms are included in this value.</p> <p>Assignment of the alarms:</p> <p>0x0002 Device fault</p> <p>0x0004 Prewarning insulation resistance R_F on L1/+</p> <p>0x0008 Prewarning insulation resistance R_F on L2/-</p> <p>0x000C Prewarning symmetrical insulation resistance R_F</p> <p>0x0010 Alarm insulation resistance R_F on L1/+</p> <p>0x0020 Alarm insulation resistance R_F on L2/-</p> <p>0x0030 Alarm insulation resistance R_F symmetrical</p> <p>0x0040 Alarm undervoltage U_n</p> <p>0x0080 Alarm overvoltage U_n</p> <p>0x0100 Message system test</p> <p>0x0200 Device start with alarm</p>
1	<p>Update counter, consecutively counts from 0 to 9.</p> <p>It increases with the update of the insulation resistance value.</p>
<CR><LF>	String end

10. Technical data

10.1 Tabular presentation

()* = Factory setting

Insulation coordination acc. to IEC 60664-1/IEC 60664-3

Definitions:

Supply circuit (IC2)	A1, A2
Output circuit (IC3)	11, 14, 24
Control circuit (IC4)	E, KE, T/R, A, B, AK1, GND, AK2

Rated voltage

Overvoltage category.....III

Rated impulse voltage:

IC2 / (IC3-4) 4 kV

IC 3 / (IC4) 4 kV

Rated insulated voltage:

IC2 / (IC3-4) 250 V

IC 3 / (IC4) 250 V

Pollution degree..... 3

Protective separation (reinforced insulation) between:

IC2 / (IC3-4) Overvoltage category III, 300 V

IC 3 / (IC4) Overvoltage category III, 300 V

Voltage test (routine test) according to IEC 61010-1:

IC2 / (IC3-4) AC 2.2 kV

IC 3 / (IC4) AC 2.2 kV

Supply voltage

Supply voltage U_s AC 100...240 V/DC 24...240 V

Tolerance of U_s -30...+15 %

Frequency range U_s 47...63 Hz

Power consumption $\leq 3 \text{ W}, \leq 9 \text{ VA}$

IT system being monitored

Nominal system voltage U_n with AGH420	3(N)AC, AC 0...690 V/DC 0...1000 V
Tolerance of U_n	AC +5 %, DC +0 %
Nominal system voltage range U_n with AGH420 (UL508)	AC/DC 0...600 V
Frequency range of U_n	DC, 15...460 Hz

Measuring circuit

Permissible system leakage capacitance C_e at insulation value ≤ 300 k Ω	≤ 1000 μ F
Permissible system leakage capacitance C_e at insulation value ≥ 300 k Ω	≤ 500 μ F
Permissible extraneous DC voltage U_{fg}	≤ 1150 V

Response values

Response value R_{an1}	2...500 k Ω (10 k Ω)*
Response value R_{an2}	1...490 k Ω (5 k Ω)*
Relative uncertainty R_{an}	± 15 %, at least ± 1 k Ω
Hysteresis R_{an}	25%, at least 1 k Ω
Undervoltage detection	30...1.14 kV (off)*
Overvoltage detection	31...1.15 kV (off)*
Relative uncertainty U	± 5 %, at least ± 5 V
Relative uncertainty depending on the frequency ≥ 200 Hz	-0.03 %/Hz
Hysteresis U	5 %, at least 5 V

Time response

Response time t_{an} at $R_f = 0.5 \times R_{an}$ and $C_e = 1$ μ F acc. to IEC 61557-8	≤ 10 s
Start-up delay t	0...10 s (0 s)*
Response delay t_{on}	0...99 s (0 s)*
Delay on release t_{off}	0...99 s (0 s)*

Displays, memory

Display	LC display, multi-functional, not illuminated
Display range measured value insulation resistance (R_f)	1 k Ω ...1 M Ω
Operating uncertainty at $R_f \leq 1$ M Ω	± 15 %, at least ± 1 k Ω
Display range measured value nominal system voltage (U_n)	30...1.15 kV $_{RMS}$
Operating uncertainty	± 5 %, at least ± 5 V
Relative uncertainty depending on the frequency ≥ 200 Hz	-0.03 %/Hz

Display range measured value system leakage capacitance at $R_f > 10 \text{ k}\Omega$	0 ... 1000 μF
Operating uncertainty	$\pm 15 \%$, at least $\pm 2 \mu\text{F}$
Password	off/0 ... 999 (0, off)*
Fault memory alarm messages	on/(off)*

Interface

Interface/protocol	RS-485/BMS, Modbus RTU, isoData
Baud rate	BMS (9.6 kBit/s), Modbus RTU (selectable), isoData (115.2 kBits/s)
Cable length (9.6 kBits/s)	$\leq 1200 \text{ m}$
Cable: twisted pairs, shield connected to PE on one side	min. J-Y(St)Y 2x0.6
Terminating resistor	120 Ω (0,25 W), internal, can be connected
Device address, BMS bus, Modbus RTU	3 ... 90 (3)*

Switching elements

Switching elements	2 x 1 N/O contacts, common terminal 11
Operating principle	N/C operation/N/O operation (N/O operation)*
Electrical endurance, number of cycles	10000
Contact data acc. to IEC 60947-5-1:	
Utilisation category	AC-12 AC-14 DC-12 DC-12 DC-12
Rated operational voltage	230 V 230 V 24 V 110 V 220 V
Rated operational current	5 A 2 A 1 A 0.2 A 0.1 A
Minimum contact rating	1 mA at AC/DC $\geq 10 \text{ V}$

Environment/EMC

EMC	IEC 61326-2-4
Ambient temperatures:	
Operation	-40 ... +70 $^{\circ}\text{C}$
Transport	-40 ... +85 $^{\circ}\text{C}$
Storage	-40 ... +70 $^{\circ}\text{C}$
Classification of climatic conditions acc. to IEC 60721	
Stationary use (IEC 60721-3-3)	3K7 (except condensation and formation of ice)
Transport (IEC 60721-3-2)	2K4 (except condensation and formation of ice)
Long-term storage (IEC 60721-3-1)	1K5 (except condensation and formation of ice)

Classification of mechanical conditions acc. to IEC 60721

Stationary use (IEC 60721-3-3)	3M4
Transport (IEC 60721-3-2)	2M2
Long-term storage (IEC 60721-3-1)	1M3

Connection

Connection type screw-type terminal or push-wire terminal

Screw-type terminals:

Nominal current	≤ 10 A
Tightening torque	0.5 ... 0.6 Nm (5 ... 7 lb-in)
Conductor sizes	AWG 24-12
Stripping length	8 mm
Rigid/flexible	0.2 ... 2.5 mm ²
Flexible with ferrules with/without plastic sleeve	0.25 ... 2.5 mm ²
Multi-conductor rigid	0.2 ... 1.5 mm ²
Multi-conductor flexible	0.2 ... 1.5 mm ²
Multi-conductor flexible with ferrules without plastic sleeve	0.25 ... 1.5 mm ²
Multi-conductor flexible with TWIN ferrules with plastic sleeve	0.25 ... 1.5 mm ²

Push-wire terminals:

Nominal current	≤ 10 A
Conductor sizes	AWG 24-14
Stripping length	10 mm
rigid	0.2 ... 2.5 mm ²
flexible without ferrules	0.75 ... 2.5 mm ²
flexible with ferrules with/without plastic sleeve	0.25 ... 2.5 mm ²
Multi-conductor flexible with TWIN ferrules with plastic sleeve	0.5 ... 1.5 mm ²
Opening force	50 N
Test opening, diameter	2.1 mm
Wiring of the terminals Up, AK1, GND, AK2	refer to technical data AGH420 under the heading "Connection"

Other

Operating mode	continuous operation
Mounting	cooling slots must be ventilated vertically
Degree of protection, built-in components (DIN EN 60529)	IP30
Degree of protection, terminals (DIN EN 60529)	IP20

Enclosure material	polycarbonate
DIN rail mounting acc. to	IEC 60715
Screw fixing	2 x M4 with mounting clip
Weight	≤ 150 g

Technical data AGH420

Insulation coordination acc. to IEC 60664-1/IEC 60664-3

Definitions:

Measuring circuit (IC1)	L1/+, L2/-
Control circuit (IC2)	AK1, GND, AK2, Up, E
Rated voltage	1000 V
Overtoltage category	III
Rated impulse voltage:	
IC1 / (IC2)	8 kV
Rated insulated voltage:	
IC1 / (IC2)	1000 V
Pollution degree	3
Protective separation (reinforced insulation) between:	
IC1 / (IC2)	Overtoltage category III, 1000 V

Monitored IT system

Nominal system voltage range U_n	AC/DC 0...1000 V
Tolerance of U_n	AC/DC +10 %
Nominal system voltage range U_n (UL508)	AC/DC 0...600 V

Measuring circuit

Measuring voltage U_m	±45 V
Measuring current I_m at R_F	≤ 400 μA
Internal resistance DC R_i	≥ 120 kΩ

Environment/EMC

EMC	IEC 61326-2-4
Ambient temperatures:	
Operation	-40...+70 °C
Transport	-40...+85 °C

Storage	-40 ... +70 °C
Classification of climatic conditions acc. to IEC 60721:	
Stationary use (IEC 60721-3-3)	3K7 (except condensation and formation of ice)
Transport (IEC 60721-3-2)	2K4 (except condensation and formation of ice)
Long-term storage (IEC 60721-3-1)	1K5 (except condensation and formation of ice)
Classification of mechanical conditions acc. to IEC 60721:	
Stationary use (IEC 60721-3-3)	3M4
Transport (IEC 60721-3-2)	2M2
Long-term storage (IEC 60721-3-1)	1M3

Connection

Connection type screw-type terminal or push-wire terminal

Screw-type terminals:

Nominal current	≤ 10 A
Tightening torque	0.5 ... 0.6 Nm (5 ... 7 lb-in)
Conductor sizes	AWG 24-12
Stripping length	8 mm
Rigid/flexible	0.2 ... 2.5 mm ²
Flexible with ferrules with/without plastic sleeve	0.25 ... 2.5 mm ²
Multi-conductor rigid	0.2 ... 1.5 mm ²
Multi-conductor flexible	0.2 ... 1.5 mm ²
Multi-conductor flexible with ferrules without plastic sleeve	0.25 ... 1.5 mm ²
Multi-conductor flexible with TWIN ferrules with plastic sleeve	0.25 ... 1.5 mm ²

Push-wire terminals:

Nominal current	≤ 10 A
Conductor sizes	AWG 24-14
Stripping length	10 mm
Rigid	0.2 ... 2.5 mm ²
Flexible without ferrules	0.75 ... 2.5 mm ²
Flexible with ferrules with/without plastic sleeve	0.25 ... 2.5 mm ²
Multi-conductor flexible with TWIN ferrules with plastic sleeve	0.5 ... 1.5 mm ²
Opening force	50 N
Test opening, diameter	2.1 mm
Connection type	terminals Up, AK1, GND, AK2
Single cables for terminals Up, AK1, GND, AK2:	

Cable lengths.....	≤ 0.5 m
Connection properties	≥ 0.75 mm ²

Other

Operating mode	Continuous operation
Mounting	cooling slots must be ventilated vertically
Distance to adjacent devices from $U_n > 800\text{ V}$	≥ 30 mm
Degree of protection internal components (DIN EN 60529)	IP30
Degree of protection terminals (DIN EN 60529)	IP20
Enclosure material	polycarbonate
DIN rail mounting acc. to.....	IEC 60715
Screw mounting.....	2 x M4 with mounting clip
Weight	≤ 150 g

10.2 Standards, approvals and certifications

The ISOMETER® has been developed in compliance with the following standards:

- DIN EN 61557-8 (VDE 0413-8): 2015-12/Ber1: 2016-12
- IEC 61557-8: 2014/COR1: 2016



10.3 Ordering data

Type	Version	Art. No.
isoPV425-D4-4 with AGH420	Push-wire terminal	B71036303
isoPV425-D4-4 with AGH420	Screw-type terminal	B91036303
Mounting clip for screw fixing (1 piece per device)		B98060008

INDEX

A

AGH420

- Technical data 62

C

Commissioning 25, 30

Configuration 35

- Fault memory 36
- Function 38
- Interface 37
- Relay operating mode 35
- Time 37

Connection 25, 27

Connection monitoring 19

D

Data access

- BMS 40
- Modbus RTU 41

Delay on release 22

Device characteristics 14

Display elements in use 32

E

Error codes 17, 18

F

Factory setting 22

Fault memory 23

Functional description 15

H

History memory 23, 38

How to use this manual 6

I

Installation 25

Interface/protocols

- BMS 23
- IsoData 24
- Modbus RTU 23

IsoData

- Data string 56

M

Malfunction 20

Measuring times 21

Menu

- "AL" 34

- "out" 35

- "SEt" 38

- "t" 37

- Overview 33

Menu structure 34

Modbus

- Function code 41

- Register assignment 44

Monitoring

- Insulation resistance 16

- Undervoltage and overvoltage 17

O

Operating time 21

Operation 31

Ordering information 64

P

Password protection 22

R

Relay alarm assignment 35

Reset button T/R 22

Response delay time 21

Response times 21

Response value setting 34

S

Safety instructions 12

Self-test 17

- Automatic 19

- Manual 19

Signalling assignment alarm relays K1/K2
20

Start-up delay t 22

T

Technical data 58

Total response time 21

W

Wiring diagram 28

Work activities on electrical installations 12



Bender GmbH & Co. KG

Londorfer Str. 65 • 35305 Gruenberg • Germany

Postfach 1161 • 35301 Gruenberg • Germany

Tel.: +49 6401 807-0

Fax: +49 6401 807-259

Email: info@bender.de

Web: <http://www.bender.de>

Photos: Bender archives.



BENDER Group